

# Extending Active Device Characterization: ENA-X Midrange VNA

A comparison of noise figure measurements between the  
ENA-X and PNA-X

# Contents

- Introduction ..... 3
- Common Features Between the ENA-X and PNA-X..... 4
- Advantages of an ENA-X Based Solution..... 9
- Advantages of a PNA-X Based Solution..... 12
- Conclusion ..... 16
- Resources ..... 16

# Introduction

Amplifiers and converters are essential components of RF and microwave sub-systems such as satellite transponders or radar transmit/receive modules. Noise figure is one of the key parameters that is characterized on the receiver component of these sub-systems.

Noise figure can be measured using test instrumentation such as a noise figure analyzer, spectrum analyzer, or a network analyzer. Network analyzers are often used due to other crucial measurement capability, such as S-parameters, gain compression, and intermodulation distortion. The network analyzer cold-source noise figure measurement technique available enables both accurate and efficient measurements.

During the design stage of a device, simplicity of testing (not requiring many external components) and speed of testing allow a designer to change and improve the design efficiently. In the manufacturing process, fast and simple testing allows for significant cost-savings.

Keysight's high-performance PNA-X network analyzers have been a standard solution for measuring noise figure since 2008, when the noise figure software application was first introduced. Today the same noise figure measurement capability has been added to Keysight's mid-range performance network analyzer family, the ENA-X.

This application note compares the noise figure measurement capability of the ENA-X and PNA-X.

It should be noted that this comparison is mostly in the context of noise figure measurements. There are other differences between the ENA-X and PNA-X platforms, such as availability of internal combiners, multiport and multi-site measurements, specifications such as power, harmonics, etc. Those are not covered in this paper.

The noise figure methodology and measurement science of the mid-range ENA-X is the same as the high-performance PNA-X. The ENA-X offers users a lower cost solution for active device test.



ENA-X

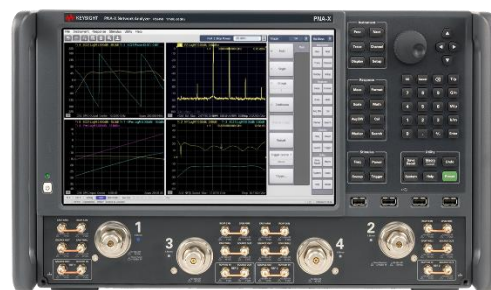

PNA-X

# Common Features Between the ENA-X and PNA-X

## Scalar and vector noise figure measurements

Both network analyzers' noise figure measurement solution is based on the cold-source technique that Keysight VNAs have been using for nearly two decades. So, the measurement science and methodology is all the same.

Both instruments offer scalar noise figure and vector noise figure measurement capability for amplifiers (NF) and converters (NFx), using the noise figure software application. With both VNAs, users have the choice of using a noise source or power sensor for the receiver characterization.

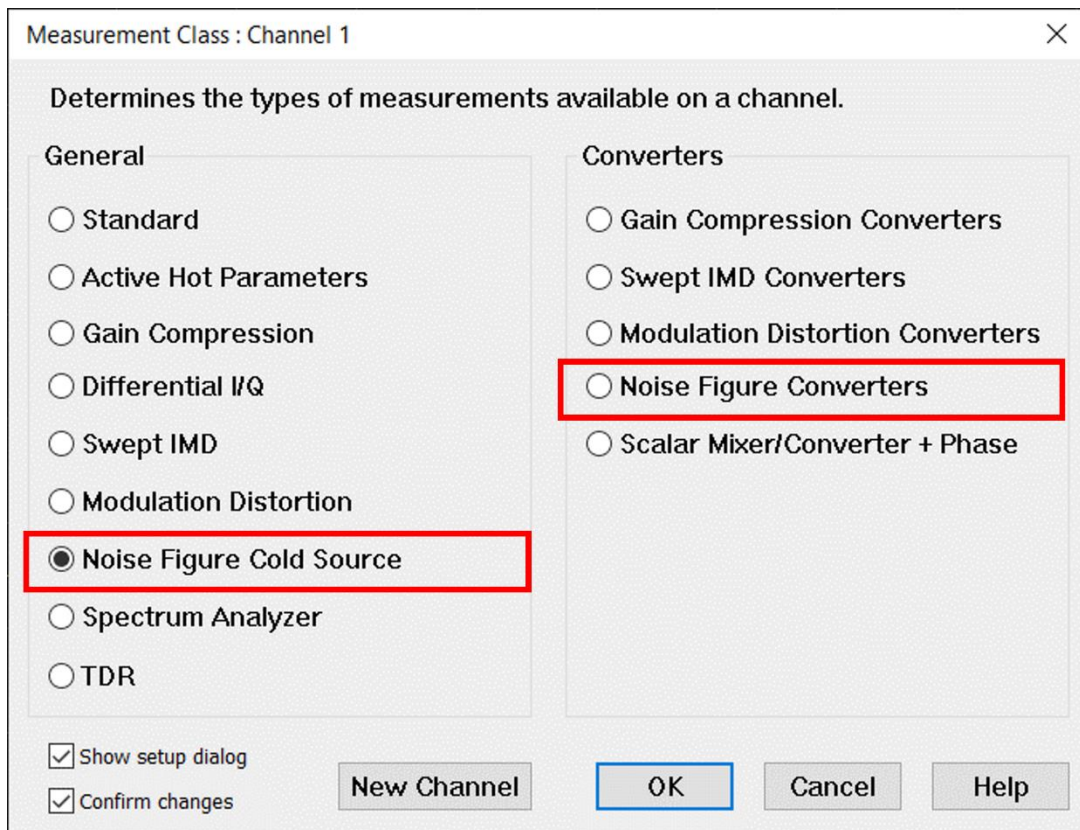

**Figure 1.** Both the ENA-X and PNA-X offer noise figure testing for amplifiers and frequency converters.

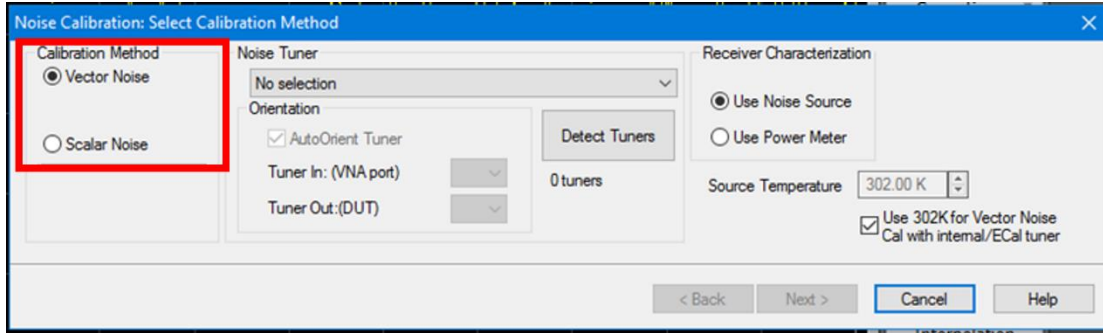

**Figure 2.** Both the ENA-X and PNA-X offer vector noise figure and scalar noise figure capability.

The software application, combined with built-in noise figure hardware, makes noise figure testing as simple as connecting the DUT to the test ports and using the software GUI to guide the user through the measurement. The same connection can be used for S-parameter, gain compression and other active device measurements.

Both instruments offer scalar noise figure and vector noise figure capability.

## Noise figure measurement comparison

The plots below show the same device measured with the ENA-X and PNA-X, using vector and scalar noise figure calibration.

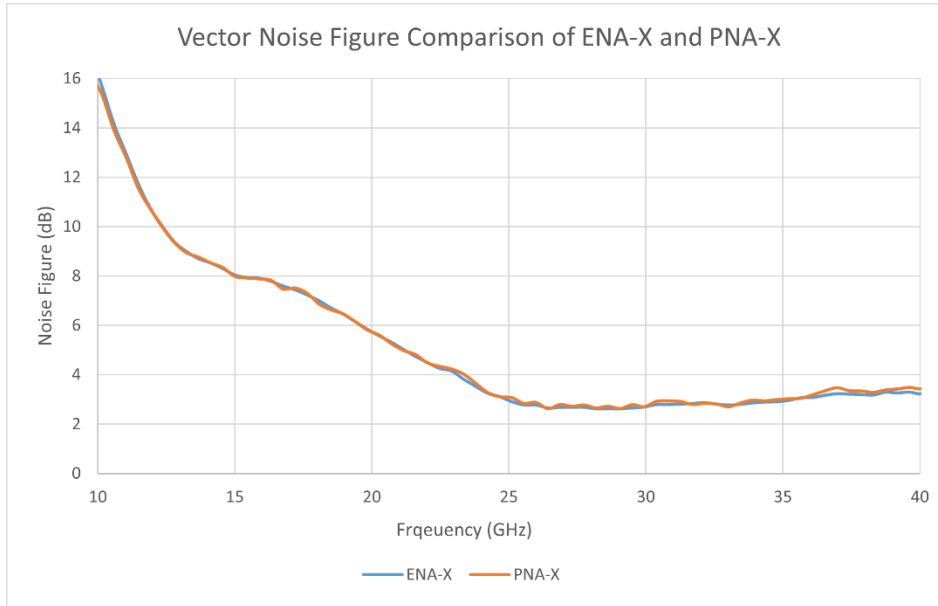

**Figure 3.** For vector noise figure measurements, the measurements are similar, though making vector measurement is more convenient with the PNA-X, as explained in later sections of this paper.

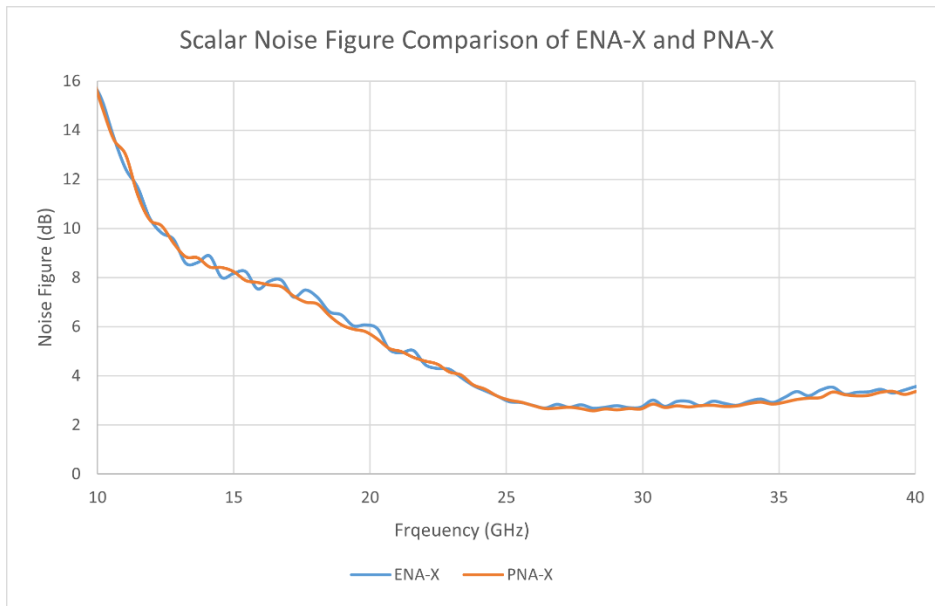
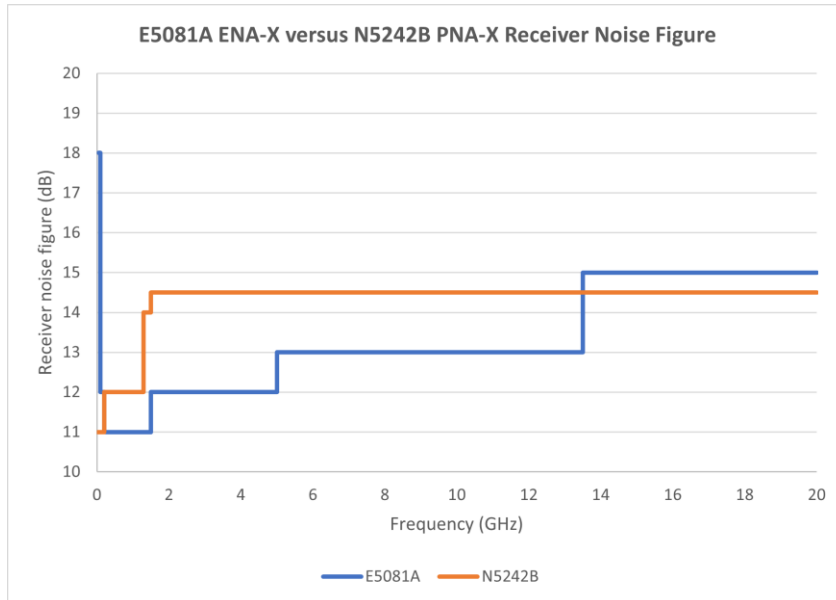

**Figure 4.** For scalar measurements, the better raw hardware performance of the PNA-X results in slightly less overall ripple.

## Receiver noise figure comparison

The specifications for receiver noise figure for each analyzer are listed in their respective Data Sheets. An abridged version is supplied here for ease-of-comparison.

### 20 GHz Solution



**Figure 5.** For frequencies less than 20 GHz, the noise figure of the ENA-X and PNA-X receivers are similar.

#### ENA-X Receiver Noise Figure (dB), Port 1 or Port 2

Frequency	Specification	Typical
50 MHz to 100 MHz	18	14
100 MHz to 200 MHz	12	9
200 MHz to 2 GHz	11	10
2 GHz to 5 GHz	12	10
5 GHz to 15 GHz	13	11
15 GHz to 20 GHz	15	13

#### PNA-X Receiver Noise Figure (dB), Port 2

Frequency	Specification	Typical
10 MHz to 200 MHz	11.0	-
200 MHz to 1.3 GHz	12.0	-
1.3 GHz to 2.0 GHz	14.0	-
2.0 GHz to 8.5 GHz	14.5	-
8.5 GHz to 13.5 GHz	14.5	-
13.5 GHz to 20 GHz	14.5	-
20 GHz to 26.5 GHz	17.0 <sup>1</sup>	-

## 44 GHz Solution

The noise figure of the ENA-X and PNA-X is similar at frequencies <35 GHz. For higher frequencies, the PNA-X has an advantage. Additionally for frequencies above 40 GHz, the ENA-X requires external filters, which are built-in for the PNA-X.

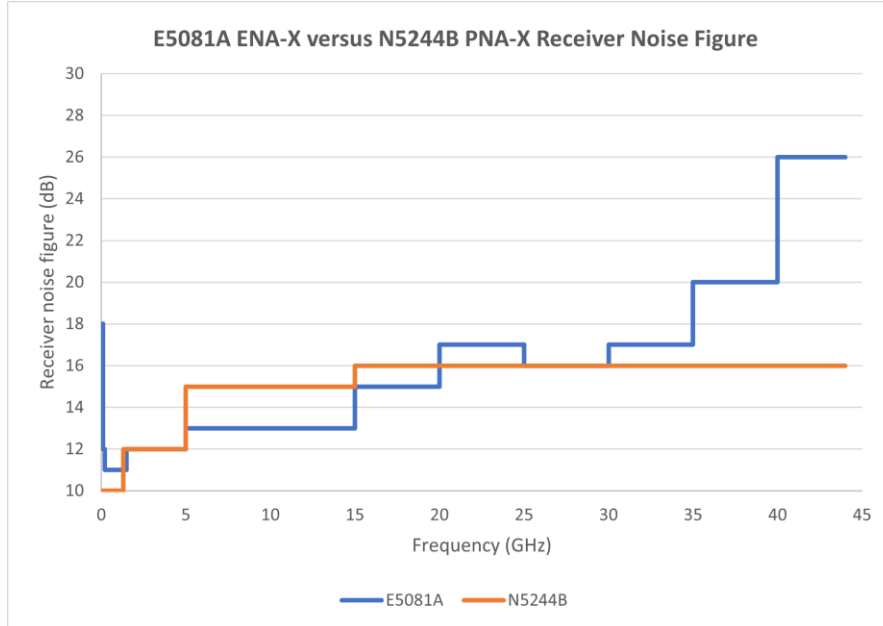

**Figure 6.** For frequencies less than 35 GHz, the VNAs have similar noise figure. For higher frequencies, the PNA-X has an advantage.

### ENA-X Receiver Noise Figure (dB), Port 1 or Port 2

Description	Specification	Typical
50 MHz to 100 MHz	18	14
100 MHz to 5GHz	12	10
5 GHz to 15 GHz	13	11
15 GHz to 20 GHz	15	13
20 GHz to 35 GHz	17	15
35 GHz to 40 GHz	20	17
40 GHz to 44 GHz	26	21

### PNA-X Receiver Noise Figure (dB), Port 2

Description	Specification	Typical
10 MHz to 50 MHz	-	9
50 MHz to 1.5 GHz	10	7
1.5 GHz to 5 GHz	12	10
5 GHz to 20 GHz	15	11
20 GHz to 45 GHz	16	11
45 GHz to 50 GHz	21	14



# Advantages of an ENA-X Based Solution

## ENA-X Advantage: Price

The PNA-X is Keysight's high performance network analyzer family. The ENA-X is Keysight's mid-range network analyzer family. For noise figure measurements, an ENA-X-based solution is approximately 70% of the cost of a PNA-X-based solution.

The tables below show sample ENA-X and PNA-X noise figure configurations.

### 20 GHz Solution

ENA-X	Description	PNA-X	Description
E5081A	ENA-X, 10 MHz to 20 GHz	N5242B	PNA-X, 10 MHz to 26.6 GHz
E5081A-2K5	2-port	N5242B-217	2-port
E5081A-0K2	Add noise receiver to port 2, 50 MHz to 20 GHz	N5242B-029	Add noise receiver, 10 MHz to 26.5 GHz
S96029B	Noise Figure Software	S93029B	Noise Figure Software

### 44 GHz Solution

ENA-X	Description	PNA-X	Description
E5081A	ENA-X, 10 MHz to 44 GHz	N5244B	PNA-X, 10 MHz to 43.5 GHz
E5081A-2N5	2-port	N5244B-217	2-port
E5081A-0N2	Add noise receiver to port 2, 50 MHz to 44 GHz	N5244B-029	Add noise receiver, 10 MHz to 43.5 GHz
S96029B	Noise Figure Software	S93029B	Noise Figure Software

An ENA-X based noise figure solution is approximately 70% of the cost of a PNA-X based solution.

## ENA-X Advantage: Size and weight

For a 20 GHz network analyzer, at 17 kg, an ENA-X weighs significantly less than a 27 kg PNA-X. An ENA-X can be moved by one person. A PNA-X is nearly always a 2-person lift. The ENA-X also has a more compact form-factor.

### 20 GHz Solution

	ENA-X E5081A with Option 2K5	PNA-X N5242B	Difference: ENA-X vs PNA-X
Weight	16.7 kg	27 kg	10.3 kg lighter
Width (including handles)	460 mm	460 mm	Same
Height (with feet)	266 mm	279 mm	Similar
Depth (including handle)	344 mm	578 mm	ENA-X has much less depth. It is 23 cm less deep.

### 44 GHz Solution

	ENA-X E5081A with Option 2N5	PNA-X N5244B	Difference: ENA-X vs PNA-X
Weight	17.4 kg	46.3 kg	<b>ENA-X is 29 kg lighter!</b>
Width (including handles)	460 mm	458.7 mm	Same
Height (with feet)	266 mm	279.1 mm	Similar
Depth (including handle)	344 mm	649.9 mm	ENA-X has much less depth. It is 30 cm less deep.



E5081A ENA-X

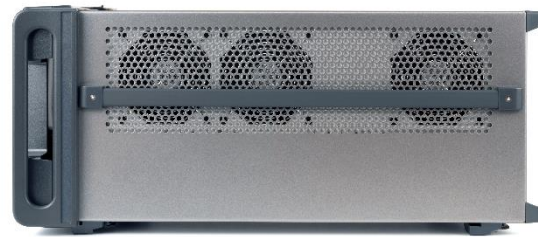

N5244B PNA-X

The ENA-X is a 1-person lift; the PNA-X is a 2-person lift. And, the ENA-X is smaller.

## ENA-X Advantage: Efficiency and flexibility of noise figure measurements

A 2-port ENA-X can be configured with either one noise receiver (port 1 or port 2) or two noise receivers (port 1 and port 2). The PNA-X can only be configured with one noise receiver, located on port 2. Having a noise receiver on both ports 1 and 2 allows for easier testing of bi-directional devices such as transceivers. With the ENA-X, if you are testing a device such as a transceiver, you can connect the Tx path from port 1 to port 2, and measure the Rx path's (generally port 2 to port 1) noise figure on port 1.

With the PNA-X, the noise receiver is on port 2, then one has to connect the Tx from port 2 to port 1, and Rx from port 1 to port 2. The downside of this hardware setup is applications such as IMD are designed to use port 1 and port 1 source 2 as the source of f1 and f2, and can't use port 2's source. Additionally, the PNA-X's port 1 has much better filtering (it's been designed as the primary source); for example, the source harmonics of port 1 are 30 dB better than port 2. For non-linear measurements on an active device, it is beneficial for the source port to be Port 1. One can add an external switch to handle this or reverse the DUT, but this is inconvenient.

## ENA-X Advantage: Availability of fast measurements

Another feature of the ENA-X is the ability to have faster noise figure measurements if more jitter in the measurement is acceptable. The PNA-X family is designed and optimized for accuracy, so it prioritizes accuracy over speed. The ENA-X allows the user to run noise figure measurements (with low values of noise averaging) that are very fast. These measurements will have more jitter though. But it is a choice that users in manufacturing environments may find warranted.

This tradeoff can be seen in the plot below. With the PNA-X (the two blue lines), if 20 noise averages are applied, the measurement has less than 0.025 dB rms noise (jitter) and it takes about 10 seconds. With the ENA-X (two orange lines), 20 noise averages results in 0.06 dB rms noise, but the sweep time is in the milliseconds. So, the ENA-X measurement is noisier but significantly faster.

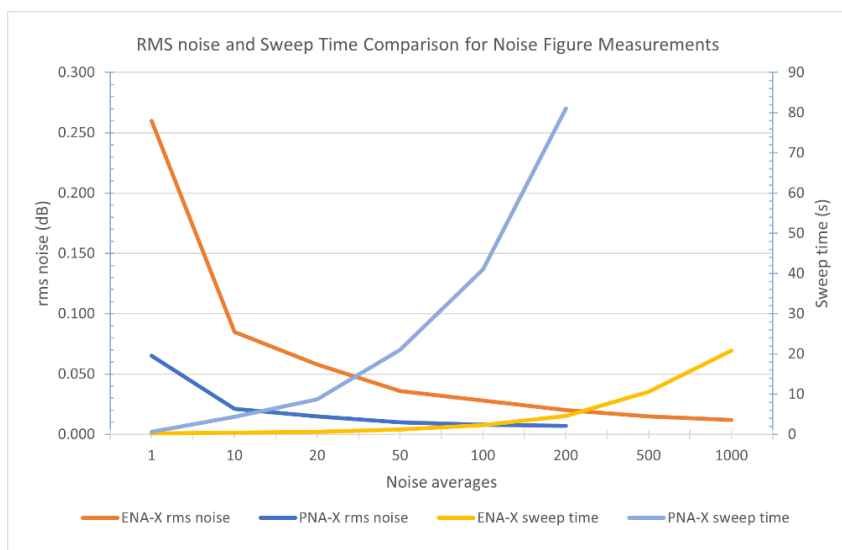

Figure 8. With the ENA-X, users can make faster noise figure measurements, if higher levels of jitter are acceptable.

# Advantages of a PNA-X Based Solution

The primary advantage of a PNA-X based solution is it is more convenient, especially in a lab environment where vector noise figure may be preferable to scalar, and also users may often change the stimulus settings. In manufacturing environments where scalar noise figure is generally the preferred choice because it is faster, and the settings are known, these factors do not come into play.

PNA-X advantage, for all frequencies:

- Built-in switch for an ECal tuner, which is used in vector noise figure (not a factor for in scalar noise figure)
- Easy 28-V bias for older 346 noise sources (not a factor for newer USB noise sources)
- Calibration validity over different gain settings

PNA-X advantage for 44 GHz solutions:

- Built-in tuner module
- Built-in filtering. ENA-X requires external filters > 40 GHz.

Each item is examined in more detail below.

## PNA-X Advantage: Built-in switch for an ECal tuner for vector noise figure

Vector noise figure measurements can use an ECal as a tuner. This ECal module is referred to as ECal-as-tuner here to contrast it with an ECal module that can be used for the S-parameter calibration.

This ECal-as-tuner module needs to be present during the noise channel calibration and noise power measurement, to present different source impedances to the DUT. The ECal-as-tuner is not used during the S-parameter portion of the measurement.

The 26.5 GHz N5242B PNA-X has a built-in mechanical switch for switching this ECal module into the path during a vector noise figure measurement. This switch is set to the thru path for non-noise figure measurements such as gain compression, harmonics or IMD. The 44 GHz N5244B has both the switch and the tuner module built-in.

The ENA-X has neither the built-in “convenience” switch, nor the tuner module. The user has two choices regarding the tuner and switch, when performing vector noise figure measurements.

- Connect the ECal module to port 1 and always leave it in the path, and accept the measurement consequences of it. The consequences are (1) a slight degradation in the S-parameter measurement accuracy due to the 7 dB loss of the ECal, and a slight increase in drift due to the worse raw directivity, again due to the loss of the ECal, (2) Some extra considerations/challenges due to ECal's compression level of around 0 dBm, combined with a loss of about 7 dB, which means the DUT cannot be driven with higher than -7 dBm.

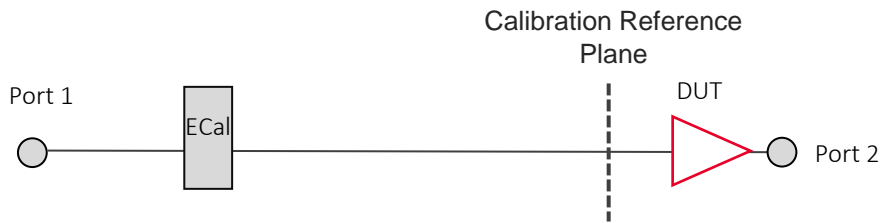

**Figure 9.** With the ENA-X, the ECal-as-tuner module can be directly connected to the test port. For vector calibration using ENA-X, the ECal thru is used for all measurements except the vector noise pulling, so all other measurements can still be performed as long as the source power does not exceed the maximum ECal power handling.

- Add an external switch (similar to the built-in switch that the PNA-X has), so the noise figure measurements are in the ECal-as-tuner path and other measurements use the thru path. This provides the same accuracy and setup as the PNA-X.

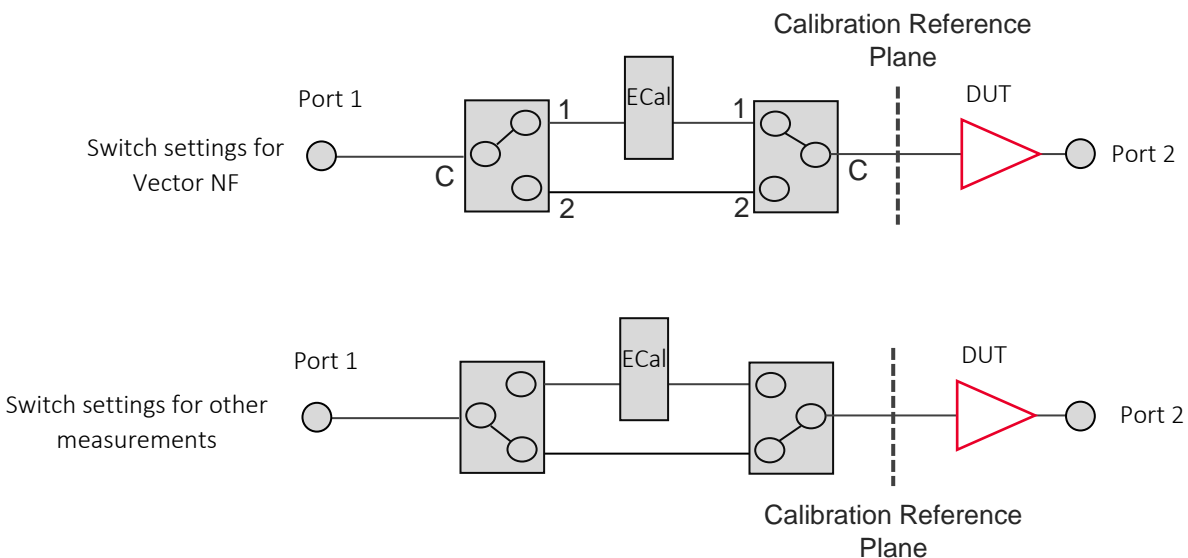

**Figure 10.** With the ENA-X, external switches to switch the ECal-as-tuner module can mimic the role of the internal switch in the PNA-X.

The PNA-X has a built-in tuner switch (26.5 GHz) or built-in switch and tuner (50 GHz). These components need to be supplied externally with an ENA-X. The tuner is only a factor for vector noise figure. It is not applicable to scalar noise figure. Scalar noise figure is the main method used in manufacturing as it requires less sweeps and is faster.

## PNA-X Advantage: Easy 28V bias for older 346 noise sources

The 28V bias BNC on the PNA-X is easier to use than the 346CH08 adapter and software on ENA-X. If using USB noise sources, there is no difference between an ENA-X and PNA-X.

While both instruments can use the 346 non-USB noise sources, the PNA-X has a built-in 28V DC voltage source with a BNC connector, making it easy to bias the older 346 noise source. With the ENA-X, the user needs to use the 346CH08 USB to BNC adapter, and run special software on the VNA to control the biasing. Once the hardware is connected and the software is running, the rest works just like the PNA-X.

This 28V biasing inconvenience is not a factor if the new USB Smart noise sources are used, as those are USB powered and work the same way with the ENA-X and PNA-X.



346C and 346CH08



USB noise source

## PNA-X Advantage: Calibration validity over different gain settings

Both the PNA-X and the ENA-X have three noise receiver gain settings: low, medium, and high.

With the PNA-X, these settings can be modified after calibration and the calibration is retained. Furthermore, the analyzer has an overload indicator, letting the user know if there is too much excess noise for a given gain setting. This will prompt the user to modify the receiver gain settings.

With the ENA-X, if the gain setting is changed after calibration, the calibration is turned off. The user needs to determine the gain setting before calibrating. Which means the user needs to know the approximate gain and noise figure, and do some calculations to determine the optimum setting. This can be done, but depending on the gain+noise figure values and how they line up against the ENA-X's noise-receiver compression values, it may or may not be obvious which gain setting one has to use.

A simple work around is to set up three channels, one for each gain setting, and calibrate all three, and then select the optimum one.

For example, the first channel is set up with high gain, then the channel is copied to channel 2, the gain is modified to medium, and then copied to channel 3, and the gain modified to low. Then Cal All is used to calibrate all three channels at once. Now all three receiver gain settings are calibrated, and the user can apply the appropriate cal set to their measurement.

In general, selecting the gain setting is less of an issue in manufacturing as the settings have already been pre-determined.

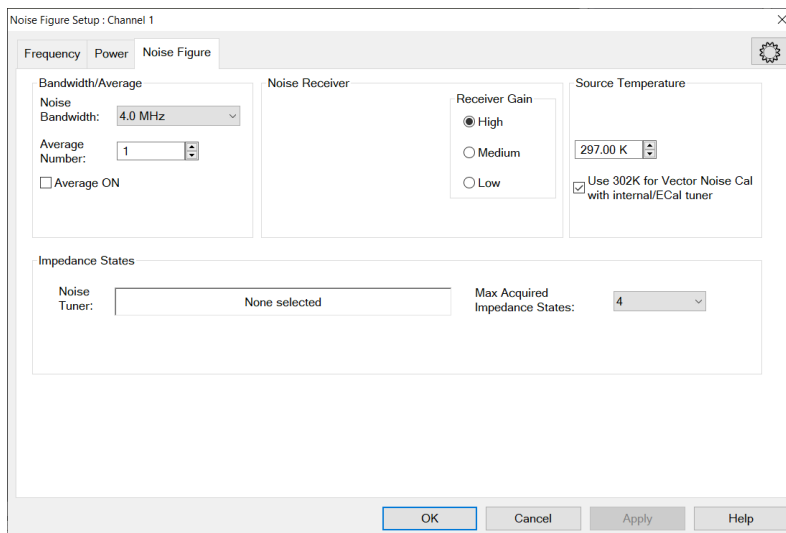

**Figure 11.** With the ENA-X, each gain setting requires its own calibration. The PNA-X's solution is more convenient to use.

The PNA-X's noise figure application maintains its calibration over different noise receiver gain settings. With the ENA-X, each gain setting requires its own calibration. The PNA-X's solution is more convenient to use.

# Conclusion

## ENA-X — A lower-cost alternative for active device noise figure characterization

Traditionally the high-performance PNA-X was the main solution for active device measurements such as noise figure. Now the mid-range ENA-X also offers noise figure capability, at a much lower cost compared to the PNA-X, offering active device test users another choice.

Feature	ENA-X E5081A	PNA-X N5242B, N5244B	Notes
Amplifier and converter noise figure applications	✓	✓	Same
Scalar noise figure	✓	✓	Same
Vector noise figure	Needs ECal + Switch	20 GHz: Needs ECal 44 GHz: no extra hardware needed	PNA-X is a more convenient solution with the built-in hardware
Price	\$	\$\$	ENA-X is 70% of the price of a PNA-X
Weight	1-person lift	2-person lift	ENA-X is 10 to 30 kg lighter
# of noise receivers	2	1	Easier to test bidirectional devices with ENA-X, or test two DUTs
Accuracy < 35 GHz	✓	✓	Similar
Accuracy and ease-of-use > 35 GHz	Needs external filters and has higher receiver noise figure	✓	PNA-X is a better solution

## Resources

- [High-Accuracy Noise Figure Measurements with Network Analyzers](#)
- [Optimizing On-Wafer Noise Figure Measurements to 67 GHz](#)
- [PNA-X noise figure FAQ](#)
- [E5081A ENA-X Data Sheet](#)

Keysight enables innovators to push the boundaries of engineering by quickly solving design, emulation, and test challenges to create the best product experiences. Start your innovation journey at [www.keysight.com](http://www.keysight.com).



This information is subject to change without notice. © Keysight Technologies, 2023 - 2014, Published in USA, April 3, 2024, 3123-1817.EN